

Register your product and get support at
www.philips.com/welcome

AZ1880



EN User manual

PHILIPS

Contents

1 Important	4
Safety	4
Notice	5

2 Your CD Soundmachine	6
Introduction	6
What's in the box	6
Overview of the main unit	7
Overview of the remote control	9

3 Get started	9
Prepare the remote control	9
Select power supply	10
Turn on	11

4 Play	11
Play disc	11
Play from USB	11

5 Play options	11
Repeat and random play	11
Program tracks	12

6 Adjust sound	12
Adjust volume	12
Mute sound	12
Enhance bass	12
Listen through headphone	12

7 Listen to radio	12
Tune to a radio station	12
Program radio stations automatically	12
Program radio stations manually	13
Select a preset radio station	13

8 Listen to an external device	13
---------------------------------------	----

9 USB record	13
Record from CD to USB	13
Delete files in the USB device	14

10 Product information	14
Specifications	14
USB playability information	14
Supported MP3 disc formats	15
Maintenance	15

11 Troubleshooting	15
---------------------------	----

1 Important

Safety

- ① Read these instructions.
- ② Keep these instructions.
- ③ Heed all warnings.
- ④ Follow all instructions.
- ⑤ Do not use this apparatus near water.
- ⑥ Clean only with dry cloth.
- ⑦ Do not block any ventilation openings. Install in accordance with the manufacturer's instructions.
- ⑧ Do not install near any heat sources such as radiators, heat registers, stoves, or other apparatus (including amplifiers) that produce heat.
- ⑨ Protect the power cord from being walked on or pinched, particularly at plugs, convenience receptacles, and the point where they exit from the apparatus.
- ⑩ Only use attachments/accessories specified by the manufacturer.
- ⑪ Use only with the cart, stand, tripod, bracket, or table specified by the manufacturer or sold with the apparatus. When a cart is used, use caution when moving the cart/apparatus combination to avoid injury from tip-over.
- ⑫ Unplug this apparatus during lightning storms or when unused for long periods of time.
- ⑬ Refer all servicing to qualified service personnel. Servicing is required when the apparatus has been damaged in any way, such as power-supply cord or plug is damaged, liquid has been spilled or



objects have fallen into the apparatus, the apparatus has been exposed to rain or moisture, does not operate normally, or has been dropped.

- ⑭ **Battery usage CAUTION** – To prevent battery leakage which may result in bodily injury, property damage, or damage to the unit:
 - Install all batteries correctly, + and - as marked on the unit.
 - Do not mix batteries (old and new or carbon and alkaline, etc.).
 - Remove batteries when the unit is not used for a long time.
- ⑮ Apparatus shall not be exposed to dripping or splashing.
- ⑯ Do not place any sources of danger on the apparatus (e.g. liquid filled objects, lighted candles).
- ⑰ This product may contain lead and mercury. Disposal of these materials may be regulated due to environmental considerations. For disposal or recycling information, please contact your local authorities or the Electronic Industries Alliance: www.eiae.org.
- ⑱ Where the MAINS plug or an appliance coupler is used as the disconnect device, the disconnect device shall remain readily operable.



Warning

- Never remove the casing of this apparatus.
- Never lubricate any part of this apparatus.
- Never place this apparatus on other electrical equipment.
- Keep this apparatus away from direct sunlight, naked flames or heat.
- Never look into the laser beam inside this apparatus.
- Ensure that you always have easy access to the power cord, plug or adaptor to disconnect this apparatus from the power.

Hearing safety

Listen at a moderate volume.

- Using headphones at a high volume can impair your hearing. This product can produce sounds in decibel ranges that may cause hearing loss for a normal person, even for exposure less than a minute. The higher decibel ranges are offered for those that may have already experienced some hearing loss.
- Sound can be deceiving. Over time your hearing 'comfort level' adapts to higher volumes of sound. So after prolonged listening, what sounds 'normal' can actually be loud and harmful to your hearing. To guard against this, set your volume to a safe level before your hearing adapts and leave it there.

To establish a safe volume level:

- Set your volume control at a low setting.
- Slowly increase the sound until you can hear it comfortably and clearly, without distortion.

Listen for reasonable periods of time:

- Prolonged exposure to sound, even at normally 'safe' levels, can also cause hearing loss.
- Be sure to use your equipment reasonably and take appropriate breaks.

Be sure to observe the following guidelines when using your headphones.

- Listen at reasonable volumes for reasonable periods of time.
- Be careful not to adjust the volume as your hearing adapts.
- Do not turn up the volume so high that you can't hear what's around you.
- You should use caution or temporarily discontinue use in potentially hazardous situations. Do not use headphones while operating a motorized vehicle, cycling, skateboarding, etc.; it may create a traffic hazard and is illegal in many areas.

Notice

This product complies with the radio interference requirements of the European Community.



This product complies with the requirements of the following directives and guidelines: 2004/108/EC + 2006/95/EC. Any changes or modifications made to this device that are not expressly approved by Philips Consumer Lifestyle may void the user's authority to operate the equipment.

The making of unauthorized copies of



copy-protected material, including computer programs, files, broadcasts and sound recordings, may be an infringement of copyrights and constitute a criminal offence. This equipment should not be used for such purposes.

Recycling

Your product is designed and manufactured with high quality materials and components, which can be recycled and reused.



When you see the crossed-out wheel bin symbol attached to a product, it means the product is covered by the European Directive 2002/96/EC:



Never dispose of your product with other household waste. Please inform yourself about the local rules on the separate collection of electrical and electronic products. The correct disposal of your old product helps prevent potentially negative consequences on the environment and human health.

Your product contains batteries covered by the European Directive 2006/66/EC, which cannot be disposed of with normal household waste.

When you see the crossed-out wheel bin symbol with the chemical symbol 'Pb', it means that the batteries comply with the requirement set by the directive for lead:



Please inform yourself about the local rules on separate collection of batteries. The correct disposal of batteries helps prevent potentially negative consequences on the environment and human health.

Environmental information

All unnecessary packaging has been omitted. We have tried to make the packaging easy to separate into three materials: cardboard (box), polystyrene foam (buffer) and polyethylene (bags, protective foam sheet.)

Your system consists of materials which can be recycled and reused if disassembled by a specialized company. Please observe the local regulations regarding the disposal of packaging materials, exhausted batteries and old equipment.

Windows Media and the Windows logo are trademarks, or registered trademarks of Microsoft Corporation in the United States and/or other countries.



This apparatus includes this label:

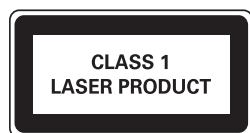

Norge

Typeskilt finnes på apparatens underside.

Observer: Nettbryteren er sekundert innkoplet. Den innebygde nettdelen er derfor ikke frakoplet nettet så lenge apparatet er tilsluttet nettkontakten.

For å redusere faren for brann eller elektrisk støt, skal apparatet ikke utsettes for regn eller fuktighet.

2 Your CD Soundmachine

Congratulations on your purchase, and welcome to Philips! To fully benefit from the support that Philips offers, register your product at www.Philips.com/welcome.

Introduction

With this unit, you can enjoy audio from discs, USB devices, external devices, or radio stations. The unit offers you Dynamic Bass Boost (DBB) to enrich sound.

The unit supports the following media formats:



What's in the box

Check and identify the contents of your package:

- Main unit
- Remote control
- 1 x AC adaptor
- 1 x MP3 link cable
- Quick start guide
- User manual

Overview of the main unit

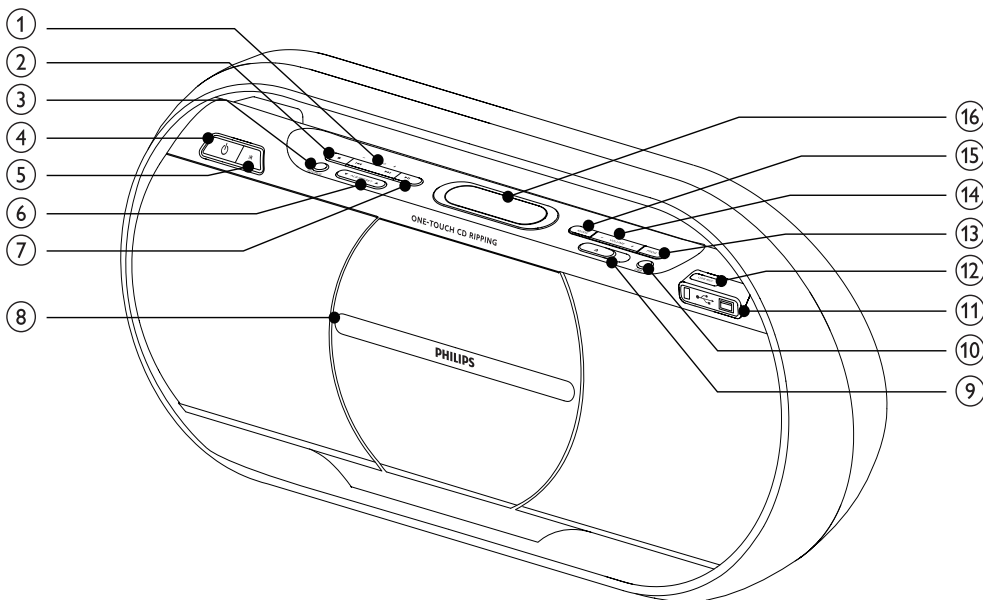

- ① **TUNING +/-**
 - Skip to the previous/next track.
 - Search within a track/ disc/USB.
 - Tune to a radio station.
- ② **■**
 - Stop play or erase a program.
- ③ **SOURCE**
 - Select a source.
- ④ **⏻**
 - Turn on or off the unit.
- ⑤ **iR**
 - Remote sensor.
- ⑥ **ALB/PRESET/▲/▼**
 - Skip to the previous/next album.
 - Select a preset radio station.
- ⑦ **▶||**
 - Start or pause play.
- ⑧ **Disc compartment door**
- ⑨ **▲**
 - Open the disc compartment.
- ⑩ **DBB**
 - Turn on or off dynamic bass enhancement.
- ⑪ **🔌**
 - Jack for a USB mass storage device.
- ⑫ **USB REC**
 - Record from a disc to a USB device.
- ⑬ **PROG**
 - Program tracks.
 - Program radio stations.
- ⑭ **VOLUME + / -**
 - Adjust volume.
- ⑮ **MODE**
 - Select repeat play or random play.
- ⑯ **Display panel**
 - Show current status.

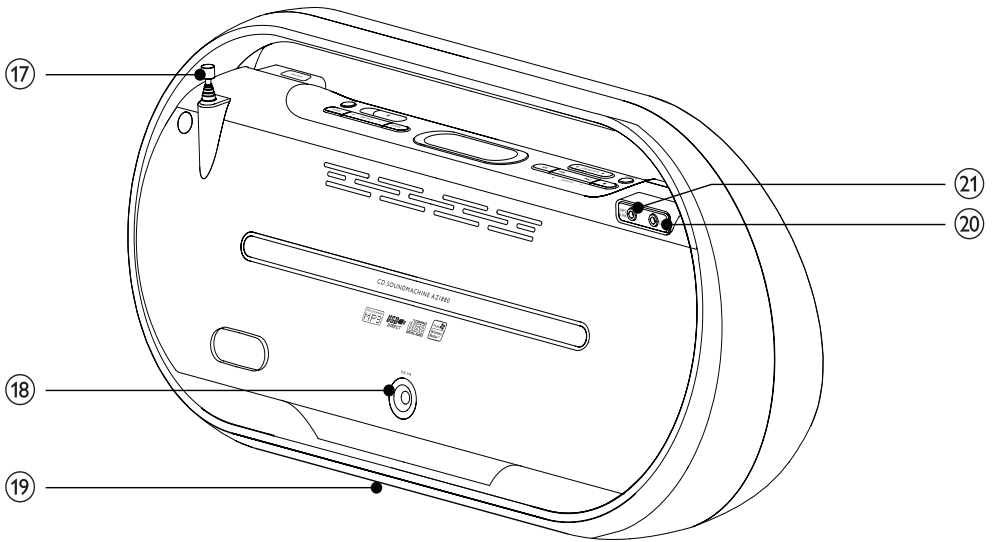

- ①⑦ **FM antenna**
 - Improve FM reception.
- ①⑧ **DC IN**
 - Jack for the supplied AC adaptor.
- ①⑨ **Battery compartment door**
- ②⑦ **MP3 LINK**
 - Audio input jack (3.5mm) for an external audio device.

Overview of the remote control

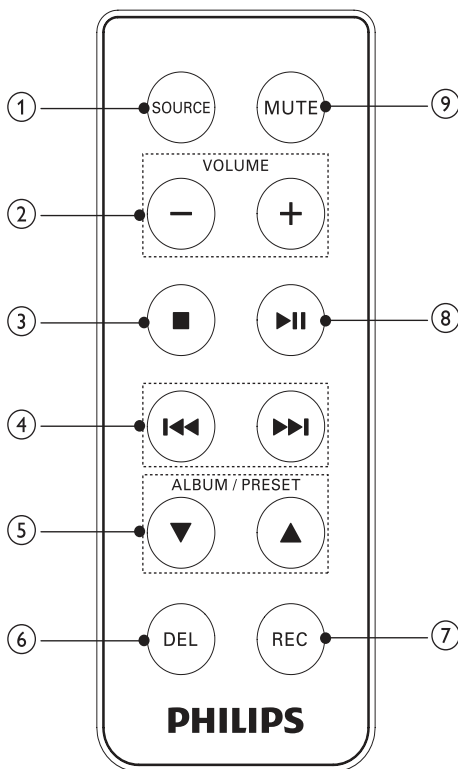

- ① **SOURCE**
 - Select a source.
- ② **VOLUME + / -**
 - Adjust volume.
- ③ **■**
 - Stop play or erase a program.
- ④ **⏮/⏭**
 - Skip to the previous/next track.
 - Search within a track/ disc/USB.
 - Tune to a radio station.
- ⑤ **ALBUM/PRESET ▲/▼**
 - Skip to the previous/next album.
 - Select a preset radio station.

- ⑥ **DEL**
 - Delete audio files stored on a USB device.
- ⑦ **REC**
 - Record from a disc to a USB device.
- ⑧ **▶||**
 - Start or pause play.
- ⑨ **MUTE**
 - Mute volume.

3 Get started

! Caution

- Use of controls or adjustments or performance of procedures other than herein may result in hazardous radiation exposure or other unsafe operation.

Always follow the instructions in this chapter in sequence.

If you contact Philips, you will be asked for the model and serial number of this apparatus. The model number and serial number are on the bottom of the apparatus. Write the numbers here:

Model No. _____

Serial No. _____

Prepare the remote control

! Caution

- Risk of explosion! Keep batteries away from heat, sunshine or fire. Never discard batteries in fire.

For first-time use:

- 1 Remove the protective tab to activate the remote control battery.

To replace the remote control battery:

- 1 Open the battery compartment: Hold the latch in the direction (A) and pull the battery tray out.
- 2 Insert 1 CR2025 battery with correct polarity (+/-) as indicated.

- 3 Close the battery compartment.

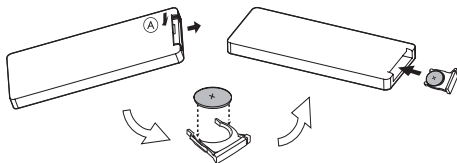

Note

- If you are not going to use the remote control for a long time, remove the battery.
- Battery contains chemical substances, so it should be disposed of properly.

Select power supply

The unit can be operated by AC power or batteries.

AC power

Caution

- Risk of product damage! Ensure that the power supply voltage corresponds to the voltage printed on the bottom of the unit.
- Risk of electric shock! When you unplug the AC adaptor, always pull the plug from the socket. Never pull the cord.
- Before connecting the AC adaptor, ensure you have completed all other connections.

Note

- The type plate is located on the bottom of the main unit.

- 1 Connect one end of the AC adaptor to the **DC IN** socket on the main unit.

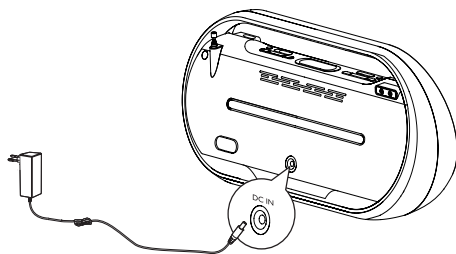

- 2 Connect the other end of the AC adaptor to the wall outlet.

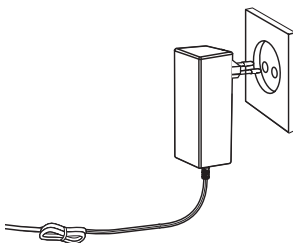

Battery power

- 1 Open the battery compartment on the bottom of the unit.
- 2 Insert 6 R14/UM2/C Cell batteries (not included) with correct polarity (+/-) as indicated, then close the battery compartment.

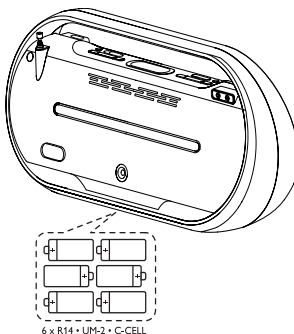

- 3 The unit is ready to operate.

Note

- Batteries contain chemical substances, so they should be disposed of properly.

Turn on

- 1 Press **⏻**.
↳ The backlight on the display panel turns on.

Turn off

- 1 Press **⏻** again to turn off the unit.
↳ The backlight on the display panel turns off.

4 Play

Play disc

- 1 Press **SOURCE** repeatedly to select the disc source.
- 2 Slide **▲** to open the disc compartment.
- 3 Insert a disc with the printed side facing outward, and close the disc compartment.
- 4 Press **▶||** to start play.
 - To pause/resume play, press **▶||**.
 - To stop play, press **■**.
 - To select another track, press **◀◀▶▶**.
 - To select an album, press **ALB/PRESET▲/▼**.

- To search within a track, press and hold **◀◀▶▶**, then release to resume normal play.

Play from USB

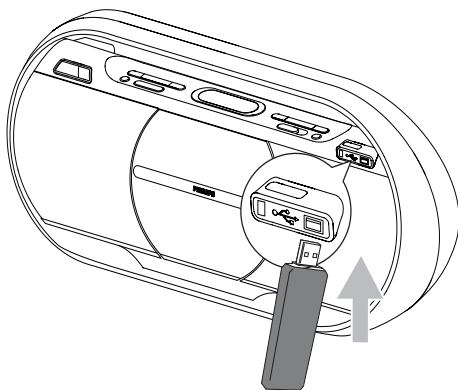

Note



- Ensure that the USB device contains playable audio contents for supported formats. (see 'USB playability information' on page 14)

- 1 Plug the USB device into the **↔** socket of the unit.
- 2 Press **SOURCE** repeatedly to select the USB source.
- 3 Press **ALB/PRESET/▲/▼** to select a folder.
- 4 Press **◀◀▶▶** to select an audio file.
- 5 Press **▶||** to start play.
 - To pause/resume play, press **▶||**.
 - To stop play, press **■**.
 - To search within an audio file, press and hold **◀◀▶▶**, then release to resume normal play.

5 Play options

Repeat and random play

- 1 Press **MODE** repeatedly to select:

- : the current track is played repeatedly.
- : all tracks are played repeatedly.
- : all tracks are played randomly.





- 2 To return to normal play, press **MODE** repeatedly until play mode is no longer displayed.

Tip

- Shuffle play cannot be selected when you play programmed tracks.

Program tracks

You can program a maximum of 40 tracks.

- 1 At CD/USB mode, in the stop position, press **PROG** to activate the program mode.
↳ [PROG] (program) is displayed.
- 2 For MP3/WMA tracks, press **ALB/PRESET**//  to select an album.
- 3 Press  to select a track number, then press **PROG** to confirm.
- 4 Repeat steps 2 to 3 to select and store all tracks to program.
- 5 Press  to play the programmed tracks.
↳ During play, [PROG] (program) is displayed.
 - To erase the program, in the stop position, press .

6 Adjust sound

Adjust volume

- 1 During play, press **VOLUME + / -** to increase/decrease the volume level.

Mute sound

- 1 During play, press **MUTE** on the remote control to mute/unmute sound.

Enhance bass





- 1 During play, press **DBB** to turn on or off dynamic bass enhancement.
↳ If DBB is activated, DBB is displayed.

Listen through headphone

- 1 Plug a headphone into the  on the back of the unit.

7 Listen to radio

Tune to a radio station

- 1 Press **SOURCE** repeatedly to select FM or MW.
- 2 Press and hold **TUNING +/-(/ )** for more than 2 seconds.
↳ [SEARCH] (search) is displayed.
↳ The radio tunes to a station with strong reception automatically.
- 3 Repeat step 2 to tune to more stations.
 - To tune to a weak station, press **TUNING +/-(/ )** repeatedly until you find optimal reception.

Program radio stations automatically

You can program a maximum of 40 (FM + MW) preset radio stations.

- 1 In the tuner mode, press and hold **PROG** for more than 2 seconds to activate automatic program mode.
↳ [AUTO] (auto) is displayed.
↳ All available stations are programmed in the order of waveband reception strength.
↳ The first programmed radio station is broadcast automatically.

Program radio stations manually

You can program a maximum of 40 (FM + MW) preset radio stations.

- 1 Tune to a radio station.
- 2 Press **PROG** to activate program mode.
↳ [PROG] (program) is displayed.
- 3 Press **ALB/PRESET/▲/▼** to allocate a number to this radio station, then press **PROG** to confirm.
- 4 Repeat the above steps to program other stations.

Select a preset radio station

- 1 In tuner mode, press **ALB/PRESET/▲/▼** to select a preset number.



Tip

- Position the antenna as far as possible from TV, VCR or other radiation source.
- For optimal reception, fully extend and adjust the position of the antenna.

8 Listen to an external device

You can also listen to an external audio device through this unit.

- 1 Press **SOURCE** repeatedly to select the MP3 link source.
- 2 Connect the supplied MP3 link cable to:
 - the **MP3 LINK** jack (3.5mm) on the back of the unit.
 - the headphone jack on an external device.
- 3 Start to play the device (refer to the device's user manual).

9 USB record



Note

- This product supports recording to MSC devices (MTP devices are excluded).

You can record the audio files on a disc into a USB device. Audio CD tracks and MP3 files are recorded in .mp3 format, and WMA files are recorded in .wma format.

The first time you record to USB, a folder called 'PHILIPS' is automatically created in the USB device. Each time you record to USB, the recorded files are stored in a sub-folder in the 'PHILIPS' folder. Files and sub-folders are named numerically in the order in which they are created.

Record from CD to USB

Prepare for recording

- 1 Plug the USB device into the  socket of the unit.
- 2 Press **SOURCE** repeatedly to select the disc source.
- 3 Load a disc.

Record one track

- 1 Play the disc and select a track.
- 2 For normal recording speed, press **USB REC**. For fast recording speed, press and hold **USB REC** for more than 2 seconds.
↳ Disc play starts automatically from the beginning of the selected track, and the recording starts.
↳ To stop recording, press **■**.

Record all tracks

- 1 Stop the disc play.
- 2 For normal recording speed, press **USB REC**. For fast recording speed, press and hold **USB REC** for more than 2 seconds.
↳ Disc play starts automatically from the beginning of the disc, and the recording starts.
↳ To stop recording, press **■**.

Note

- For a fast recording, the disc plays without sound.
- If the USB device does not have enough memory to store the audio files, [FULL] (full) is displayed.

Tip

- During USB recording at a normal speed, to avoid some possible sound drop when you listen to disc play, set the volume low and turn off the DBB function.

Delete files in the USB device

- 1 During USB play, press **⏮** to select an audio file.
- 2 Press **DEL** on the remote control.
↳ A confirmation message is displayed.
- 3 When the above confirmation message is displayed, press **DEL** again to delete.
 - To cancel, press **■**.
 - ↳ After you delete the file, the USB play stops.

10 Product information

Note

- Product information is subject to change without prior notice.

Specifications

Disc

Laser type	Semiconductor
Disc diameter	12cm/8cm
Support disc	CD-DA, CD-R, CD-RW, MP3-CD, WMA-CD

Tuner

Tuning range	FM: 87.5 - 108MHz; MW: 531 - 1602kHz
Tuning grid	50KHz (FM); 9KHz (MW)
Number of presets	40 (FM + MW)

USB

USB version	V2.0/1.1
Playability	MSC/MTP devices
Recordability	MSC devices

General information

Output power	2 × 2.5W RMS
AC power	Input: 100-240V~, 50/60Hz, 800mA MAX (0.7A); Output: 9V = 1.6A (1.56A); Brand name: Philips; Model: OH-1028A0901600U-VDE (AS140-090-DF)
Operation power consumption	10W
Dimensions	
Main Unit (W × H × D)	451 × 214.4 × 132.3 mm
Weight	2.15kg

USB playability information

Compatible USB devices:

- USB flash memory (USB 2.0 or USB 1.1)
- USB flash players (USB 2.0 or USB 1.1)
- memory cards (requires an additional card reader to work with this unit)

Supported formats:

- USB or memory file format FAT12, FAT16, FAT32 (sector size: 512 bytes)
- MP3 bit rate (data rate): 32-320 Kbps and variable bit rate
- WMA v9 or earlier

- Directory nesting up to a maximum of 8 levels
- Number of albums/ folders: maximum 99
- Number of tracks/titles: maximum 999
- ID3 tag v2.0 or later
- File name in Unicode UTF8 (maximum length: 128 bytes)

Unsupported formats:

- Empty albums: an empty album is an album that does not contain MP3/WMA files, and is not be shown in the display.
- Unsupported file formats are skipped. For example, Word documents (.doc) or MP3 files with extension .dlf are ignored and not played.
- AAC, WAV, PCM audio files
- DRM protected WMA files (.wav, .m4a, .m4p, .mp4, .aac)
- WMA files in Lossless format

Supported MP3 disc formats

- ISO9660, Joliet
- Maximum title number: 999 (depending on file name length)
- Maximum album number: 99
- Supported sampling frequencies: 32 kHz, 44.1kHz, 48 kHz
- Supported Bit-rates: 32-320 (kbps), variable bit rates
- ID3 tag v2.0 or later
- Directory nesting up to a maximum of 8 levels

Maintenance

Clean the cabinet

- Use a soft cloth slightly moistened with a mild detergent solution. Do not use a solution containing alcohol, spirits, ammonia or abrasives.

Clean discs.

- When a disc becomes dirty, clean it with a cleaning cloth. Wipe the disc from the centre out



- Do not use solvents such as benzene, thinner, commercially available cleaners, or antistatic spray intended for analogue records.

Clean the disc lens

- After prolonged use, dirt or dust may accumulate at the disc lens. To ensure good play quality, clean the disc lens with Philips CD lens cleaner or any commercially available cleaner. Follow the instructions supplied with cleaner.

11 Troubleshooting



Warning

- Never remove the casing of this apparatus.

To keep the warranty valid, never try to repair the system yourself.

If you encounter problems when using this apparatus, check the following points before requesting service. If the problem remains unsolved, go to the Philips web site www.philips.com/welcome. When you contact Philips, ensure that the apparatus is nearby and the model number and serial number are available.

No power/No sound

- Ensure that the AC power plug of the unit is connected properly.
- Ensure that there is power at the AC outlet.
- Ensure that the batteries are installed correctly.
- Adjust the volume.
- The file is a non-audio one. Select an audio file.

No response from the unit

- Disconnect and reconnect the AC power plug, then turn on the unit again.

No disc detected

- Insert a disc.
- Check if the disc is inserted with the print side facing inward.

- Wait until the moisture condensation at the lens has cleared.
- Replace or clean the disc.
- Use a finalized CD or correct format disc.

Remote control does not work

- Before pressing any function button, first select the correct source with the remote control instead of the main unit.
- Reduce the distance between the remote control and the unit.
- Insert the battery with its polarities (+/- signs) aligned as indicated.
- Replace the battery.
- Aim the remote control directly at the sensor on the front of the unit.

Poor radio reception

- Increase the distance between the unit and your TV or VCR.
- Fully extend and adjust the FM antenna.

Cannot display some files in USB device

- The number of folders or files in the USB device has exceeded a certain limit. This phenomenon is not a malfunction.
- The formats of these files are not supported.

USB device not supported

- The USB device is incompatible with the unit. Try another one.

Some sound drops from disc play during USB recording

- Set the volume lower and turn off the DBB function.

No audio file on a disc can be recorded to the USB device.

- This product supports recording to MSC devices only. Select an MSC device for recording.

